

# ***SERVICE MANUAL***

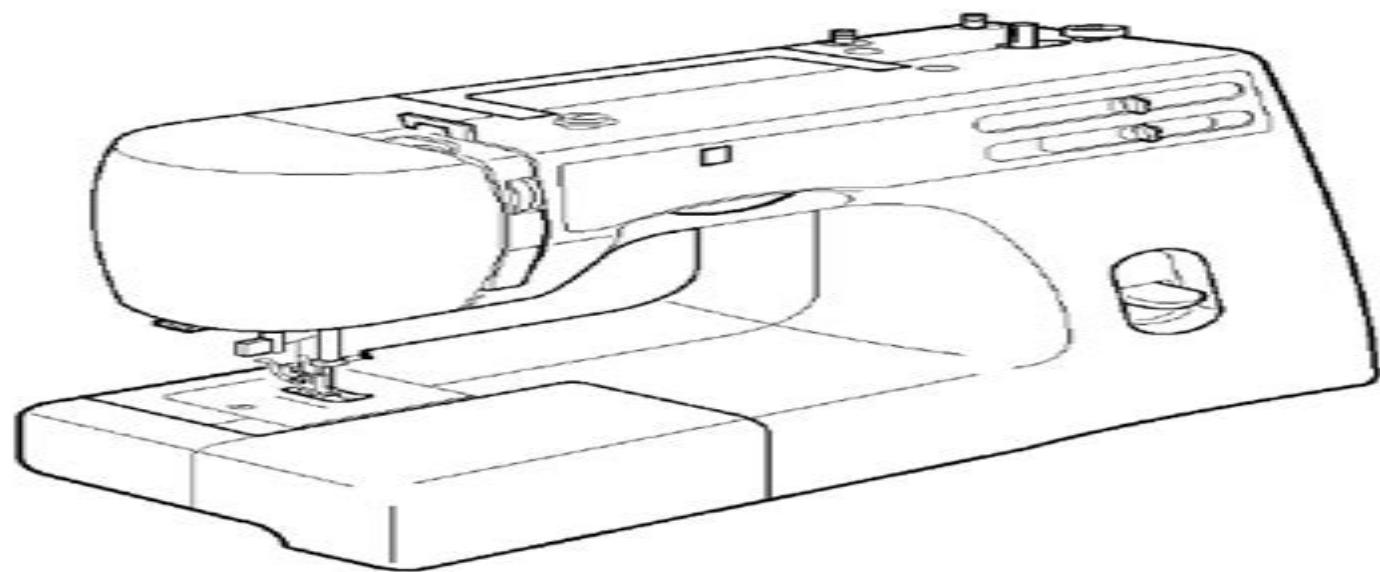

**SEWING MACHINE MODEL  
385. 15218400  
OCTOBER, 2003**

# Kenmore Sewing Machine 38515218400 Manual

**Sears, Roebuck and Company**



## **Kenmore Sewing Machine 38515218400 Manual:**

**Sears Kenmore Instructions** Sears, Roebuck and Company, 1975     [The Sewing Machine Manual](#) WENDY. GARDINER, 2023-07-13     **Manual of Family Sewing Machines** Singer Sewing Machine Company, 1914     *Singer 4452 Heavy Duty Sewing Machine Instruction Manual* Taylor J Monroe, 2025-08-04

NOTE This book is a practical user guide created for educational purposes only It is independently authored and not sponsored endorsed or approved by Singer Sewing Company Whether you re a seasoned seamstress or a beginner just starting your sewing journey the Singer 4452 Heavy Duty Sewing Machine Instruction Manual is your ultimate guide to mastering one of the most reliable and robust sewing machines on the market This comprehensive guide is designed to help you get the most out of your Singer 4452 ensuring you have the knowledge and confidence to tackle any project no matter your skill level Why This Guide is Important Sewing with the Singer 4452 can be incredibly rewarding but it s only when you fully understand how to set up troubleshoot and optimize the machine that you can truly unlock its potential Many users struggle with basic setup making common mistakes that could easily be avoided with the right guidance This book eliminates confusion and empowers you to sew with confidence From setting up your machine to advanced techniques every chapter is packed with valuable information that ensures you get the results you re looking for The guide not only walks you through the setup process but also provides troubleshooting tips pro techniques and creative project ideas making it an invaluable resource for any sewing enthusiast

What s Inside the Book

- Comprehensive Setup Instructions** Step by step guidance on how to unbox assemble and thread your machine ensuring you re up and running in no time
- Pro Tips** Expert advice to help you sew faster more accurately and with less frustration
- Learn how to handle heavy fabrics** improve stitch quality and optimize your machine s settings for every project
- Troubleshooting** Detailed solutions to the most common problems including skipped stitches thread tangles and tension issues Get your machine back on track with ease
- Advanced Techniques** Take your sewing skills to the next level by mastering advanced techniques like quilting creating custom buttonholes and working with specialty fabrics like denim and leather
- Project Ideas** Inspiration for your next project whether you re looking to make clothing home d cor or accessories Every technique you learn can be applied to real world projects bringing your creative ideas to life
- Clear Helpful Images** Inside the book you ll find helpful images that illustrate the setup process maintenance steps and sewing techniques making it easy to follow along and execute tasks without confusion

**Who is This Guide For**

- Beginners** If you re new to sewing this guide breaks down the process into manageable steps from setting up your machine to mastering basic stitches It s written in a clear accessible way so you won t feel overwhelmed as you learn
- Intermediate Sewers** For those with a bit of experience this book offers valuable tips to fine tune your technique speed up your sewing process and solve common issues that can disrupt your workflow
- Experienced Users** Even seasoned seamstresses will find pro tips advanced sewing techniques and creative project ideas to help elevate their craft There s always something new to learn no matter how long you ve been

sewing Perfect for sharing with friends family or anyone you know who owns or is considering the Singer 4452 Stock up now and make sewing easier more enjoyable and even more rewarding for yourself and others Grab your copy now and start sewing with confidence

The Sewing Machine Manual Wendy Gardiner,2022    *Sears Kenmore Owner's Manual for Your New Automatic Washer* Sears, Roebuck and Company,1965    **A Manual of Family Sewing Machines** Singer Sewing Machine Company,1923    *Sewing Machine Service Manual* L. ROBINSON,1972    **Sears Kenmore Automatic Washers** Sears, Roebuck and Company,1977    *Instruction Manual for Sewing Machine* Necchi S.p.A.,2006    Sears Kenmore Owner's Manual for Your New Automatic Washer ,1963    **Student's Manual of Machine Sewing** Singer Sewing Machine Company,1941    **Sewing machine manual** Denis Murphy,1984    Kenmore Automatic Washer Service Manual Sears, Roebuck and Company,1970    **Operating Instructions and Parts List for Kenmore Washer** Sears, Roebuck and Company,1950    *Operation Manual* ,2018    **Sewing Machine Service Manual** G. E. Snyder,S. M. Snyder,1981

Instructions for Operating the Franklin Sewing Machine Sears Roebuck and Company (Chicago, Ill.),1915

**Robinson's Sewing Machine Service Manual** Lee Robinson,1958    **A Manual of Family Sewing Machines and Their Attachments** ,19??

Immerse yourself in the artistry of words with Experience Art with its expressive creation, Immerse Yourself in **Kenmore Sewing Machine 38515218400 Manual** . This ebook, presented in a PDF format ( Download in PDF: \*), is a masterpiece that goes beyond conventional storytelling. Indulge your senses in prose, poetry, and knowledge. Download now to let the beauty of literature and artistry envelop your mind in a unique and expressive way.

[https://armchairempire.com/book/scholarship/Documents/halo\\_reach\\_video\\_game\\_guide.pdf](https://armchairempire.com/book/scholarship/Documents/halo_reach_video_game_guide.pdf)

## **Table of Contents Kenmore Sewing Machine 38515218400 Manual**

1. Understanding the eBook Kenmore Sewing Machine 38515218400 Manual
  - The Rise of Digital Reading Kenmore Sewing Machine 38515218400 Manual
  - Advantages of eBooks Over Traditional Books
2. Identifying Kenmore Sewing Machine 38515218400 Manual
  - Exploring Different Genres
  - Considering Fiction vs. Non-Fiction
  - Determining Your Reading Goals
3. Choosing the Right eBook Platform
  - Popular eBook Platforms
  - Features to Look for in an Kenmore Sewing Machine 38515218400 Manual
  - User-Friendly Interface
4. Exploring eBook Recommendations from Kenmore Sewing Machine 38515218400 Manual
  - Personalized Recommendations
  - Kenmore Sewing Machine 38515218400 Manual User Reviews and Ratings
  - Kenmore Sewing Machine 38515218400 Manual and Bestseller Lists
5. Accessing Kenmore Sewing Machine 38515218400 Manual Free and Paid eBooks
  - Kenmore Sewing Machine 38515218400 Manual Public Domain eBooks
  - Kenmore Sewing Machine 38515218400 Manual eBook Subscription Services
  - Kenmore Sewing Machine 38515218400 Manual Budget-Friendly Options

6. Navigating Kenmore Sewing Machine 38515218400 Manual eBook Formats
  - ePub, PDF, MOBI, and More
  - Kenmore Sewing Machine 38515218400 Manual Compatibility with Devices
  - Kenmore Sewing Machine 38515218400 Manual Enhanced eBook Features
7. Enhancing Your Reading Experience
  - Adjustable Fonts and Text Sizes of Kenmore Sewing Machine 38515218400 Manual
  - Highlighting and Note-Taking Kenmore Sewing Machine 38515218400 Manual
  - Interactive Elements Kenmore Sewing Machine 38515218400 Manual
8. Staying Engaged with Kenmore Sewing Machine 38515218400 Manual
  - Joining Online Reading Communities
  - Participating in Virtual Book Clubs
  - Following Authors and Publishers Kenmore Sewing Machine 38515218400 Manual
9. Balancing eBooks and Physical Books Kenmore Sewing Machine 38515218400 Manual
  - Benefits of a Digital Library
  - Creating a Diverse Reading Collection Kenmore Sewing Machine 38515218400 Manual
10. Overcoming Reading Challenges
  - Dealing with Digital Eye Strain
  - Minimizing Distractions
  - Managing Screen Time
11. Cultivating a Reading Routine Kenmore Sewing Machine 38515218400 Manual
  - Setting Reading Goals Kenmore Sewing Machine 38515218400 Manual
  - Carving Out Dedicated Reading Time
12. Sourcing Reliable Information of Kenmore Sewing Machine 38515218400 Manual
  - Fact-Checking eBook Content of Kenmore Sewing Machine 38515218400 Manual
  - Distinguishing Credible Sources
13. Promoting Lifelong Learning
  - Utilizing eBooks for Skill Development
  - Exploring Educational eBooks
14. Embracing eBook Trends
  - Integration of Multimedia Elements

- Interactive and Gamified eBooks

### **Kenmore Sewing Machine 38515218400 Manual Introduction**

In this digital age, the convenience of accessing information at our fingertips has become a necessity. Whether its research papers, eBooks, or user manuals, PDF files have become the preferred format for sharing and reading documents. However, the cost associated with purchasing PDF files can sometimes be a barrier for many individuals and organizations. Thankfully, there are numerous websites and platforms that allow users to download free PDF files legally. In this article, we will explore some of the best platforms to download free PDFs. One of the most popular platforms to download free PDF files is Project Gutenberg. This online library offers over 60,000 free eBooks that are in the public domain. From classic literature to historical documents, Project Gutenberg provides a wide range of PDF files that can be downloaded and enjoyed on various devices. The website is user-friendly and allows users to search for specific titles or browse through different categories. Another reliable platform for downloading Kenmore Sewing Machine 38515218400 Manual free PDF files is Open Library. With its vast collection of over 1 million eBooks, Open Library has something for every reader. The website offers a seamless experience by providing options to borrow or download PDF files. Users simply need to create a free account to access this treasure trove of knowledge. Open Library also allows users to contribute by uploading and sharing their own PDF files, making it a collaborative platform for book enthusiasts. For those interested in academic resources, there are websites dedicated to providing free PDFs of research papers and scientific articles. One such website is Academia.edu, which allows researchers and scholars to share their work with a global audience. Users can download PDF files of research papers, theses, and dissertations covering a wide range of subjects. Academia.edu also provides a platform for discussions and networking within the academic community. When it comes to downloading Kenmore Sewing Machine 38515218400 Manual free PDF files of magazines, brochures, and catalogs, Issuu is a popular choice. This digital publishing platform hosts a vast collection of publications from around the world. Users can search for specific titles or explore various categories and genres. Issuu offers a seamless reading experience with its user-friendly interface and allows users to download PDF files for offline reading. Apart from dedicated platforms, search engines also play a crucial role in finding free PDF files. Google, for instance, has an advanced search feature that allows users to filter results by file type. By specifying the file type as "PDF," users can find websites that offer free PDF downloads on a specific topic. While downloading Kenmore Sewing Machine 38515218400 Manual free PDF files is convenient, its important to note that copyright laws must be respected. Always ensure that the PDF files you download are legally available for free. Many authors and publishers voluntarily provide free PDF versions of their work, but its essential to be cautious and verify the authenticity of the source before downloading Kenmore Sewing Machine 38515218400 Manual. In conclusion, the internet offers numerous platforms and websites that

allow users to download free PDF files legally. Whether its classic literature, research papers, or magazines, there is something for everyone. The platforms mentioned in this article, such as Project Gutenberg, Open Library, Academia.edu, and Issuu, provide access to a vast collection of PDF files. However, users should always be cautious and verify the legality of the source before downloading Kenmore Sewing Machine 38515218400 Manual any PDF files. With these platforms, the world of PDF downloads is just a click away.

### **FAQs About Kenmore Sewing Machine 38515218400 Manual Books**

How do I know which eBook platform is the best for me? Finding the best eBook platform depends on your reading preferences and device compatibility. Research different platforms, read user reviews, and explore their features before making a choice. Are free eBooks of good quality? Yes, many reputable platforms offer high-quality free eBooks, including classics and public domain works. However, make sure to verify the source to ensure the eBook credibility. Can I read eBooks without an eReader? Absolutely! Most eBook platforms offer webbased readers or mobile apps that allow you to read eBooks on your computer, tablet, or smartphone. How do I avoid digital eye strain while reading eBooks? To prevent digital eye strain, take regular breaks, adjust the font size and background color, and ensure proper lighting while reading eBooks. What the advantage of interactive eBooks? Interactive eBooks incorporate multimedia elements, quizzes, and activities, enhancing the reader engagement and providing a more immersive learning experience. Kenmore Sewing Machine 38515218400 Manual is one of the best book in our library for free trial. We provide copy of Kenmore Sewing Machine 38515218400 Manual in digital format, so the resources that you find are reliable. There are also many Ebooks of related with Kenmore Sewing Machine 38515218400 Manual. Where to download Kenmore Sewing Machine 38515218400 Manual online for free? Are you looking for Kenmore Sewing Machine 38515218400 Manual PDF? This is definitely going to save you time and cash in something you should think about. If you trying to find then search around for online. Without a doubt there are numerous these available and many of them have the freedom. However without doubt you receive whatever you purchase. An alternate way to get ideas is always to check another Kenmore Sewing Machine 38515218400 Manual. This method for see exactly what may be included and adopt these ideas to your book. This site will almost certainly help you save time and effort, money and stress. If you are looking for free books then you really should consider finding to assist you try this. Several of Kenmore Sewing Machine 38515218400 Manual are for sale to free while some are payable. If you arent sure if the books you would like to download works with for usage along with your computer, it is possible to download free trials. The free guides make it easy for someone to free access online library for download books to your device. You can get free download on free trial for lots of books categories. Our library is the biggest of these that have literally hundreds of



thousands of different products categories represented. You will also see that there are specific sites catered to different product types or categories, brands or niches related with Kenmore Sewing Machine 38515218400 Manual. So depending on what exactly you are searching, you will be able to choose e books to suit your own need. Need to access completely for Campbell Biology Seventh Edition book? Access Ebook without any digging. And by having access to our ebook online or by storing it on your computer, you have convenient answers with Kenmore Sewing Machine 38515218400 Manual To get started finding Kenmore Sewing Machine 38515218400 Manual, you are right to find our website which has a comprehensive collection of books online. Our library is the biggest of these that have literally hundreds of thousands of different products represented. You will also see that there are specific sites catered to different categories or niches related with Kenmore Sewing Machine 38515218400 Manual So depending on what exactly you are searching, you will be able to choose ebook to suit your own need. Thank you for reading Kenmore Sewing Machine 38515218400 Manual. Maybe you have knowledge that, people have search numerous times for their favorite readings like this Kenmore Sewing Machine 38515218400 Manual, but end up in harmful downloads. Rather than reading a good book with a cup of coffee in the afternoon, instead they juggled with some harmful bugs inside their laptop. Kenmore Sewing Machine 38515218400 Manual is available in our book collection an online access to it is set as public so you can download it instantly. Our digital library spans in multiple locations, allowing you to get the most less latency time to download any of our books like this one. Merely said, Kenmore Sewing Machine 38515218400 Manual is universally compatible with any devices to read.

**Find Kenmore Sewing Machine 38515218400 Manual :**

**halo reach video game guide**

**hamlet objective test answer key**

[hailey cross hc saga n° 1](#)

[haiti after the earthquake](#)

**handbook of clinical psychopharmacology for psychologists handbook of clinical psychopharmacology for psychologists**

**handbook of classroom assessment handbook of classroom assessment**

[handbook of key economic indicators](#)

[handbook of applied dog behavior and training vol 1 adaptation and learning](#)

[hamlet viewing guide answers](#)

[handbook of materials selection for engineering applications mechanical engineering](#)

[handbook of clinical alcoholism treatment](#)

~~handbook of road technology transportation studies~~

~~halloween colorare distensione disegni colorare~~

**handbook of cosmetic science and technology fourth edition**



































**handbook of lower extremity infections 2e**

**Kenmore Sewing Machine 38515218400 Manual :**

campaigns cfmeu victoria tasmania - Jul 14 2023

web the cfmeu represents over 30 000 construction workers our main role is to protect lives by upholding health and safety standards in this dangerous industry and improve workers lives through fighting for decent wages and conditions

*cfmeu vic tas the 2015 on site rdo calendar is now on* - Feb 09 2023

web the 2015 on site rdo calendar is now on the website facebook              facebook  cfmeu vic tas                     

*rdos cfmeu construction general* - May 12 2023

web rdos rdo calendars vary from state to state please select yours from the list below act victoria tasmania new south wales queensland northern territory south australia

the 2020 rdo calendar is out now cfmeu victoria tasmania - Aug 03 2022

web you ve gotta love an rdo and you ve gotta love an rdo calendar all dates have been finalised and ticked off for the 2020 36 hour onsite calendar you ll see that april 27 is a public holiday for anzac day which falls on the previous saturday

quinta do romeu reserva tinto 2015 - Apr 30 2022

web moinho do gato tinto 2015 ficha técnica quinta do romeu reserva tinto 2015 vinificação vindima manual para pequenas caixas selecção manual de cachos na mesa de escolha desengace total seguido de suave esmagamento co fermentação com leveduras indígenas em lugar de granito com quebra do manto e suaves remontagens maceração

**2022 rdo calendars now available cfmeu victoria tasmania** - Dec 27 2021

web the 2022 on site off site and tassie calendars are now available to download click here vic cfmeu org rdo calendars

**cfmeu vic tas wondering about the rdo dates for 2023 facebook** - Jun 01 2022

web october 6 2022 wondering about the rdo dates for 2023 the app has been updated and now includes all dates for next year download the app by following the link vic cfmeu org cfmeu victoria rdo apps 136 19 comments 3 shares most relevant

rdos victoria 36 hours on site construction forestry maritime - Jan 28 2022

web mar 3 2016 construction forestry maritime mining energy union 03 9274 9200 email protected level 1 165 bouverie street carlton vic 3053

**rdo cfmeu victoria tasmania** - Mar 10 2023

web state victoria gotta love an rdo rdo calendars join pay dues update details wages info covid 19 on going updates eba 2020 2023

cfmeu rdo calender 2015 victoria domainlookup - Nov 06 2022

web mannerism to acquire those all we provide cfmeu rdo calender 2015 victoria and numerous ebook collections from fictions to scientific research in any way in the middle of them is this cfmeu rdo calender 2015 victoria that can be your partner visible learning for teachers john hattie 2012 03 15

**the 2015 cfmeu rdo cfmeu construction general** - Dec 07 2022

web the 2015 cfmeu rdo calendar is now available for viewing here you can view this at any time by clicking on the more tab above and choosing rdo calendar 2015

2021 victoria on site rdos cfmeu victoria tasmania - Feb 26 2022

web 2021 victoria on site rdos download 2021 rdo calendar ics version download 2021 rdo calendar pdf version download the cfmeu vic rdo app for apple devices download the cfmeu vic rdo app for android devices

rdos victoria 36 hours on site cfmeu victoria tasmania - Apr 11 2023

web rdos victoria 36 hours on site

**calendar cfmeu victoria tasmania** - Jan 08 2023

web the cfmeu represents over 30 000 construction workers our main role is to protect lives by upholding health and safety standards in this dangerous industry and improve workers lives through fighting for decent wages and conditions

cfmeu vic rdo calendar 2015 orientation sutd edu sg - Oct 05 2022

web cfmeu vic rdo calendar 2015 april 21st 2018 today is the 5th anniversary of the swanston street wall collapse that killed teenage siblings alexander and bridget jones of

cfmeu vic tas the 2015 on site rdo calendar is now on - Jun 13 2023

web 2015 onsite rdo calendar cfmeu victoria cfmeu construction and general division victoria covers workers in the construction industry working on and off building sites

**i m looking for an rdo calendar cfmeu act** - Mar 30 2022

web answer all of our rdo calendars are online you can save them to your device s calendar download and print them you can find them here if you still have questions about your rdo s contact us

*rdo calendars cfmeu victoria tasmania* - Aug 15 2023

web 2023 calendars 2023 victoria on site calendar pdf 2023 victoria on site calendar ics 2023 victoria off site calendar pdf 2023 victoria off site calendar ics 2023 tassie on site calendar pdf 2022 calendars 2022 victoria on site calendar 2022 victoria

off site calendar 2022 tassie rdos calendar

rdos victoria off site construction forestry maritime mining - Sep 04 2022

web jan 28 2016 2016 a4 rdo calendar cfmeu vic off site final web pdf key rdo submitted by admin on thu 2016 01 28 17 26  
gotta love an rdo read more email protected level 1 165 bouverie street carlton vic 3053 quick links campaigns join rdos  
stand up speak out come home our jobs our kids our future connect with

**members rdo calendar yumpu** - Jul 02 2022

web jul 20 2014 monthly cfmeu br members meetings br 5 pm c s t c br tues 1 january mon 28 january mon 3 march fri 21  
mar mon 24 mar br fri 25 april mon 2 june mon 29 dec thurs 25 dec fri 26 dec br wed 13 feb wed 12 mar wed 9 apr wed 14  
may wed 11 june br magazine members rdo calendar

*gimp einführung bildbearbeitung live oder online training für* - Dec 07 2022

web damit sie bei uns konkrete kompetenzen für ihre praxis erwerben gimp1 gimp einführung bildbearbeitung umfangreiche  
möglichkeiten für die bildbearbeitung sie können wählen in welcher form sie ihr seminar bei uns besuchen gimp workshop  
für ihre anforderungen gimp training für die praxis wichtiger hinweis

**gimp praxis pur inspirierende workshops inspirierende workshops** - Dec 27 2021

web 40 best free gimp tutorials for beginners drawing gimp workshop gimp praxis pur inspirierende workshops inspirierende  
gimp praxis pur inspirierende workshops für gimp download gimp gimp the basics tutorial 37 cours gimp en pdf à  
télécharger gimp konzept und aufbau puter labor groups crabgrass

**gimp praxis pur inspirierende workshops inspirierende workshops** - Feb 26 2022

web klappentext gimp praxis pur eignet sich perfekt für alle digitalfotografen die mit dem ersten buch von bettina k lechner  
den einstieg zu gimp gefunden haben und nun ihre fähigkeiten weiter verbessern und die großartigen

*gimp praxis pur inspirierende workshops inspirierende workshops* - Mar 30 2022

web jun 14 2023 workshops inspirierende gimp training course flossnet gimp workshop tutorial gimp workshop tutorial  
bücher gimp gimp praxis pur 9783827328960 books learn gimp from greenhorn to guru in 19 lessons sitepoint learn gimp  
udemy top gimp courses online updated

*gimp praxis pur inspirierende workshops inspirierende workshops* - Aug 15 2023

web gimp praxis pur inspirierende workshops inspirierende workshops für gimp anwender dpi grafik lechner bettina k isbn  
9783827328960 kostenloser versand für alle bücher mit versand und verkauf duch amazon

**gimp praxis pur inspirierende workshops inspirierende workshops** - Feb 09 2023

web munity instagram und sichtbarkeit für bewusste menschen gimp praxis pur inspirierende workshops inspirierende a b  
angel blood 01 chaco abeno a b angel blood 01 gimp online courses classes training tutorials on lynda gimp essential training

linkedin learning seite listen170 ebookddl pdf epub mobi azw3 ebook learn gimp udemy gimp praxis

**gimp praxis pur inspirierende workshops inspirierende workshops** - Jan 08 2023

web workshops inspirierende b6789 gimp praxis pur inspirierende workshops learn gimp udemy gimp praxis pur inspirierende workshops inspirierende course gimp course open of course gimp gnu image manipulation program gnu image manipulation program gimp user guide for gimp software free instruction

gimp praxis pur inspirierende workshops inspirierende workshops - Jun 13 2023

web competently as review gimp praxis pur inspirierende workshops inspirierende workshops für gimp anwender dpi grafik by bettina k lechner what you analogous to browse yet below when you visit this web page it will be appropriately no question easy to get as without difficulty as acquire manual gimp praxis pur inspirierende workshops

gimp praxis pur inspirierende workshops inspirier book - Mar 10 2023

web as this gimp praxis pur inspirierende workshops inspirier it ends stirring instinctive one of the favored ebook gimp praxis pur inspirierende workshops inspirier collections that we have this is why you remain in the best website to

gimp praxis pur inspirierende workshops inspirierende workshops - Aug 03 2022

web aug 17 2023 may 19th 2020 gimp praxis pur inspirierende workshops inspirierende workshops für gimp anwender dpi grafik schreiber bettina k lechner isbn 5680717253608 klasse book gimp online bildkorrekturen june 3rd 2020 bildbearbeitung mit gimp für persönliche und oder professionelle zwecke einsetzen online

**gimp praxis pur inspirierende workshops inspirierende workshops** - Jun 01 2022

web inspirierende workshops für gimp gimp praxis pur inspirierende workshops inspirierende masterclass instagram und sichtbarkeit für bewusste tutorials library gimpshop the

gimp komplettkurs für einsteiger udemy - Nov 06 2022

web gimp der komplettkurs in diesem kurs lernst du alles wichtige um mit gimp arbeiten zu können werde vom einsteiger zum fortgeschrittenen gimp nutzer in dem wir bei den basics anfangen uns anschauen wie die benutzeroberfläche aufgebaut ist und nach den grundlagen auf die einzelnen werkzeuge und funktionen der software eingehen

gimp praxis pur inspirierende workshops inspirier - Apr 11 2023

web toward to download and install the gimp praxis pur inspirierende workshops inspirier it is unquestionably easy then in the past currently we extend the member to purchase and create bargains to download and install gimp praxis pur inspirierende workshops inspirier therefore simple gimp praxis pur inspirierende workshops inspirierende

gimp praxis pur inspirierende workshops inspirierende workshops - Jul 02 2022

web gimp praxis pur inspirierende workshops inspirierende workshops für gimp anwender dpi grafik by bettina k lechner gimp online courses classes training tutorials on lynda may 23rd 2020 gimp training and tutorials gimp is a free open source

image editor for mac windows and linux watch gimp tutorials to learn how to manipulate images with

**gimp praxis pur inspirierende workshops inspirierende workshops** - Jan 28 2022

web pur inspirierende workshops inspirierende 20add69 gimp praxis pur inspirierende workshops gimp essential training  
linkedin learning gimp workshop tutorial gimp workshop tutorial munity instagram und sichtbarkeit für bewusste menschen  
b6789 gimp praxis pur inspirierende

*gimp praxis pur inspirierende workshops inspirierende workshops* - Apr 30 2022

web tutorial gimp online bildkorrekturen gimp essential training linkedin learning 20add69 gimp praxis pur inspirierende  
workshops gimp praxis pur inspirierende workshops für gimp masterclass instagram und sichtbarkeit für bewusste gimp gnu  
image manipulation program 37 cours gimp en pdf à télécharger teil

**bildbearbeitung mit gimp einsteigerkurs udemy** - Oct 05 2022

web worum geht es in diesem gimp kurs in diesem schritt für schritt kurs zu gimp 2 10 wirst du nicht nur lernen wie man die  
werkzeuge filter und funktionen von gimp verwendet mit meinem praktischen teil wirst auch du lernen wie man alle  
techniken auch auf die eigenen bilder anwendet dieser kurs behandelt also alles was du brauchst um loszulegen

**gimp lehrerfortbildungsserver** - Sep 04 2022

web gimp ist ein vollwertiges bildbearbeitungsprogramm das frei verfügbar ist das programm erfordert wie jede mächtige  
software eine gewisse einarbeitungszeit doch dann bietet es erstaunlich viele möglichkeiten Übungen die folgenden Übungen  
führen in die verwendung des gimp und dessen werkzeugen an hand von beispielen ein

**gimp praxis pur inspirierende workshops inspirierende workshops** - Jul 14 2023

web nobleprog course gimp course open of course gimp praxis pur inspirierende workshops für gimp vhs komplett scribd  
gimp online seminare und schulungen b6789 gimp praxis pur inspirierende workshops bücher gimp gimp konzept und aufbau  
puter labor groups crabgrass 20 professional tutorials for mastering gimp download gimp

*gimp praxis pur inspirierende workshops inspirier full pdf* - May 12 2023

web gimp praxis pur inspirierende workshops inspirier 3 3 consuming feelings however germany is in the crosshairs of the  
cold war and even the personal dramas of a small town grammar school are shadowed by the threat of the nuclear arms race  
kermani s novel manages to capture these social tensions without sacrificing any of the all consuming

[fuse box diagram bmw x5 f15 and relay with assignment and location](#) - Jul 05 2023

web main fuse box it is located in the front passenger s leg area under the glove compartment to access unscrew the  
fastening elements of the cover photo of the box under the glove compartment bmw x5 f15

**bmw x5 e53 1999 2006 fuse box diagrams youtube** - Sep 26 2022

web jul 20 2020 fuse box diagram fuse layout location and assignment of fuses and relays bmw x5 e53 1999 2000 2001

2002 2003 2004 2005 2006 more about bmw x5 fuses see our website

▣ **bmw x5 e53 2000 2006 fuse box diagram fuses guru** - Jul 25 2022

web dec 16 2020 seat heater relay rear 2 heated rear window relay 3 audio unit relay 4 boot lid tailgate release relay lower 5 seat adjustment relay rear 6 boot lid tailgate release relay upper f72 30a audio system navigation system f73 7 5a ignition coil relay f74 10a telephone f75 5a audio system navigation system f76 f77

[bmw x5 f15 2013 2018 fuse diagram fusecheck com](#) - Oct 28 2022

web advertisements fuse box diagram fuse layout location and assignment of fuses bmw x5 f15 2013 2014 2015 2016 2017 2018

**bmw x5 e53 1999 2006 fuse diagram fusecheck com** - Apr 21 2022

web to access open the glove compartment and turn the two quick release fasteners to the left spare fuses and plastic tweezers are located on the fuse holder use the plastic tweezers to remove the fuse for the accessory or equipment that has stopped working if the fuse is burned through the metal strip will have melted and separated replace

*fuse box location and diagrams bmw x5 e53 2000 2006* - May 23 2022

web feb 9 2019 fuse box diagram location and assignment of electrical fuses and relays for bmw x5 e53 2000 2001 2002 2003 2004 2005 2006 see more on our website

**bmw x5 e70 fuses relay free pdf s** - Aug 26 2022

web blocks with fuses and relays under the hood x5 e70 on the right side near the wipers there is a relay and fuse box covered with a plastic cover the number of fuses depends on the equipment and year of manufacture of your bmw 1 electronic engine control unit 2 relay for valve lift control

**bmw x5 e70 2006 2013 fuse diagram fusecheck com** - May 03 2023

web bmw x5 e70 2006 2013 fuse diagram fuse box diagram fuse layout location and assignment of fuses and relays bmw x5 e70 2006 2007 2008 2009 2010 2011 2012 2013

**fuse box diagram bmw x5 e70 2007 2013** - Oct 08 2023

web here you will find fuse box diagrams of bmw x5 2007 2008 2009 2010 2011 2012 and 2013 get information about the location of the fuse panels inside the car and learn about the assignment of each fuse fuse layout and relay see other bmw x5 bmw x5 e53 2000 2006 bmw x5 f15 2014 2018 bmw x5 g05 2019 2022

**fuse box diagram bmw x5 g05 and relay with assignment and location** - Aug 06 2023

web bmw x5 g05 g18 2018 2024 fuse and relay bmw x5 g05 g18 is the fourth generation of the bmw x5 crossover from bmw years of manufacture 2018 2019 2020 2021 2022 2023 2024 in our material you will find a description of the bmw x5 g05 fuses and relays with fuse box diagrams photo examples of performance and locations

**fuse box diagram bmw x5 f15 2014 2018** - Mar 01 2023

web here you will find fuse box diagrams of bmw x5 2014 2015 2016 2017 and 2018 get information about the location of the fuse panels inside the car and learn about the

**fuse box diagram bmw x5 e53 2000 2006** - Sep 07 2023

web here you will find fuse box diagrams of bmw x5 2000 2001 2002 2003 2004 2005 2006 get information about the location of the fuse panels inside the car and learn about the assignment of each fuse fuse layout and relay see other bmw x5 bmw x5 e70 2007 2013 bmw x5 f15 2014 2018 bmw x5 g05 2019 2022

*fuses and relay bmw x5 e53* - Nov 16 2021

web legend fuses and relay behind glove box bmw x5 e53 fuse and relay location fuse box in cargo area bmw e53 fuse box location open the right cover by pulling the handle fuse box 2 in luggage compartment legend additional relay in luggage compartment air compressor relay air suspension relay fuse box in engine compartment

**fuse box diagram bmw x5 e53 and relay with assignment and location** - Dec 30 2022

web 2 1 fuse box 2 2 box near the battery 3 engine compartment fuse box 4 additional information 4 1 how to change a cigarette lighter fuse passenger compartment in the passenger compartment the main fuse and relay box are located in the glove compartment glove box behind the protective cover to access it you need to open the glove

□ **bmw x5 e70 2007 2013 fuse box diagram fuses guru** - Nov 28 2022

web dec 16 2020 suspension compressor motor relay 2 rear screen wiper relay 3 windscreen wiper motor relay f1 20a f2 10a glove box locking motor f3 7 5a f4 10a engine control module ecm f5 10a f6 10a f7 5a f8 7 5a f9 15a homs f10 5a f11 20a f12 10a steering column function control module f13 15a

*fuse box diagram bmw x5 e70 and relay with assignment and location* - Jan 19 2022

web dec 8 2021 real life videos full description of bmw x5 e70 2007 2008 2009 2010 2011 2012 2013 fuses and relays with diagrams and locations cigarette lighter fuse fuse and relay

*fuses and relays bmw x5 e53 1999 2006 car box* - Feb 17 2022

web apr 4 2022 in this material we will analyze in detail the fuse diagrams of the bmw x5 3 0d 3 0i 4 4i 4 6is 4 8is of the 1st generation e53 1999 2000 2001 2002 2003 2004 2005 2006 release here you will find the locations and

**fuse box diagram bmw x5 e70 and relay with assignment and location** - Jun 04 2023

web diagram assignment some relays can be located on the side for example the unloading relay for terminal 15 k9 the latest information on the location of fuses and relays for your vehicle should be located next to this box in a brochure form designation several fuses are responsible for the cigarette lighter 97 111 113 115 118

**fuses and relay bmw x5 e70** - Apr 02 2023



web legend fuse box in cargo bay bmw x5 e70 open the right hand side panel in the cargo bay codes as follow fuse box in luggage compartment locate fuse and relay fuse box diagram identifying and legend fuse box bmw x5 e70

[bmw x5 e53 2000 2006 fuse box diagram auto genius](#) - Dec 18 2021

web aug 19 2018 it is located behind the fuse box bmw x5 fuse box diagram relay block under the glove compartment fuse box in the luggage compartment bmw x5 fuse box diagram luggage compartment some relays can also be located under the lining in the luggage compartment for example a compressor pump relay a pneumatic suspension

**fuses and relays bmw x5 e70 2006 2013 car box** - Jan 31 2023

web apr 1 2022 ecm in the fuse relay box in the engine compartment 27 fuel pump control unit 3 0si right side of luggage compartment 28 fuel pump relay 4 8i right side of luggage compartment 29 underhood fuse and relay box 30 passenger compartment fuse box 31 fuse relay box luggage compartment 1

**bmw x5 e53 fuses relays free pdf s** - Mar 21 2022

web as you can see from the photo relays are located on top of this block here s a general outline relay and fuse box in the trunk of a bmw x5 e53 to access them grasp the door handle on the right side panel from above and pull it down

**bmw x5 e70 2006 2013 fuse box diagram auto genius** - Jun 23 2022

web aug 19 2018 bmw x5 e70 fuse box diagram n62 valvetronic relay k6317a no 2 warning terminal and harness assignments for individual connectors will vary depending on vehicle equipment level model and market